

Rollenschiebereinheiten

Roller slide units

Unités de coulisseau à rouleaux

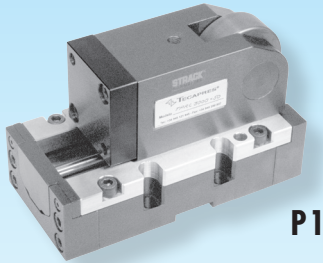

P1

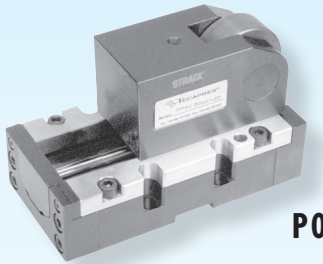

P0

Type 2000

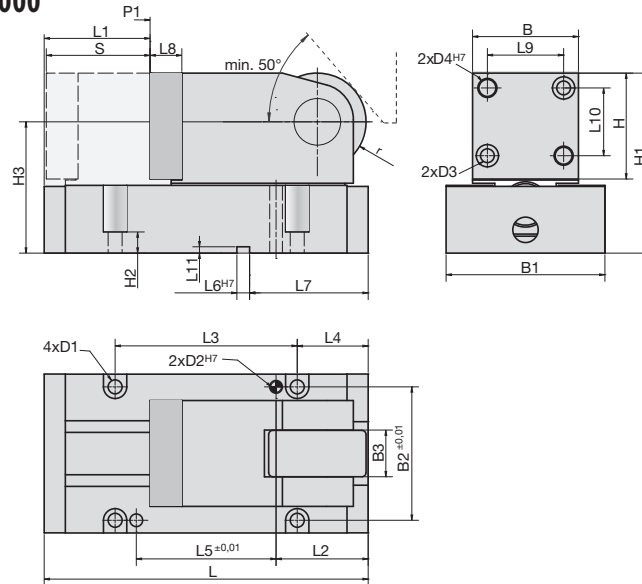

SN5620-



Type 3000 - 15000

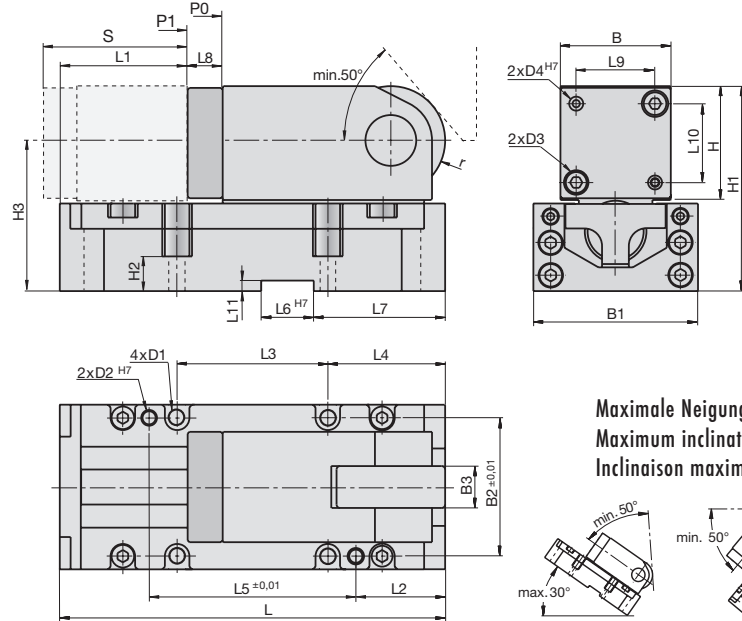

P1 mit Montageplatte
P0 ohne Montageplatte
P1 with mounting plate
P0 without mounting plate
P1 avec plaque de montage
P0 sans plaque de montage

Zwangsrückzug auf Anfrage
Forced return on demand
Retour force sur demande

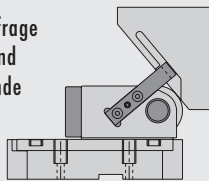

S = Hub / Stroke / Course

Type	S	L	L1	L2	L3	L4	L5	L6	L7	L8	L9	L10	L11	B	B1	B2	B3	D1	D2	D3	D4	H	H1	H2	H3	r
2000	50	153	51	43,5	86	33,5	66	6	56	15	36	32	3	50	75	63	22	M6	6	M6	8	50	85	10	62	23
3000	50	190	43	51	56	67	88	30	75	20	45	45	6	63	94	79	24	M8	8	M8	8	63	117	20	86	31
3000	80	220	73	51	86	67	118	30	75	20	45	45	6	63	94	79	24	M8	8	M8	8	63	117	20	86	31
5000	50	190	43	51	56	67	88	30	75	20	70	54	6	90	120	105	28	M8	8	M8	8	74	140	20	103	36
5000	80	220	73	51	86	67	118	30	75	20	70	54	6	90	120	105	28	M8	8	M8	8	74	140	20	103	36
5000	100	260	103	51	126	67	158	30	75	30	70	54	6	90	120	105	28	M8	8	M8	8	74	157	20	120	36
15000	50	190	43	51	56	67	88	30	75				6	135	170	155	50	M8	8			90	165	20	120	45
15000	80	220	73	51	86	67	118	30	75				6	135	170	155	50	M8	8			90	165	20	120	45
15000	100	260	113	51	126	67	158	30	75				6	135	170	155	50	M8	8			90	165	20	120	45



SN5620-Type-S-P-F

Bestelltabelle auf nächster Seite / Order-chart on next page / Tableau commande en prochain page

Rollenschiebereinheiten SN5620				Roller slide units SN5620				Unités de coulisseau à rouleaux SN5620			
Type	S	P	F	Gasdruckfeder Gas spring Ressort à gaz	F [daN] = 400		Gasdruckfeder Gas spring Ressort à gaz	F [daN] = 200		Max. Arbeitskraft Max. punching force Force de poinçonnage max.	
					daN	daN		daN	daN		
2000	50	1	170	SN2808-V-170-50-4	170	255	-	-	-	2000 daN	
3000	50	0 / 1	400/200 (ISO)	SN2809-400-50-4	400	635	SN2820-200-50-4*	200	290	3000 daN	
3000	80	0 / 1	400/200 (ISO)	SN2809-400-80-4	400	635	SN2820-200-80-4*	200	290	3000 daN	
5000	50	0 / 1	400/200 (ISO)	SN2809-400-50-4	400	635	SN2820-200-50-4*	200	290	5000 daN	
5000	80	0 / 1	400/200 (ISO)	SN2809-400-80-4	400	635	SN2820-200-80-4*	200	290	5000 daN	
5000	100	0 / 1	400/200 (ISO)	SN2809-400-100-4	400	635	SN2820-200-100-4*	200	290	5000 daN	
15000	50	0	400 (ISO)	2 x SN2800-200-50-4*	2 x 200	2 x 270	-	200	270	15000 daN	
15000	80	0	400 (ISO)	2 x SN2800-200-80-4*	2 x 200	2 x 270	-	200	270	15000 daN	
15000	100	0	400 (ISO)	2 x SN2800-200-100-4*	2 x 200	2 x 270	-	200	270	15000 daN	

Lieferung ohne Montageplatte auf Anfrage / On request, delivery without mounting plate / Sur demande, livraison sans plaque de montage

* VDI 3003/ISO 11901-1

Maximale Belastung in Abhängigkeit von der Stempelposition nach FEM Analyse.

Maximal load in dependence of the punch position after FEM analysis.

Charge maximale dépendant de la position du poinçon après FEM analyse.

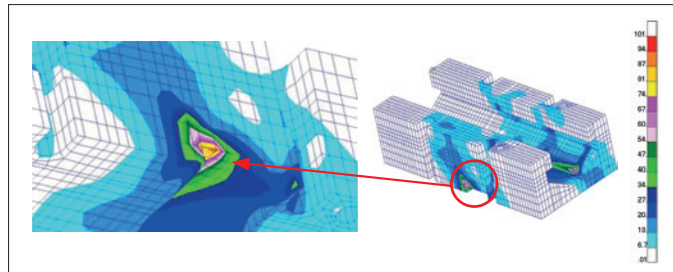
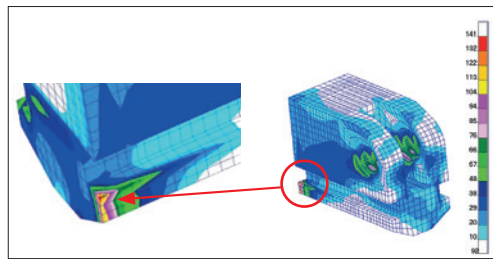

8

Belastungsdiagramme SN5620-2000 / 3000 / 5000 / 15000

Load diagrams SN5620-2000 / 3000 / 5000 / 15000

Diagrammes de charge SN5620-2000 / 3000 / 5000 / 15000

SN5620-2000

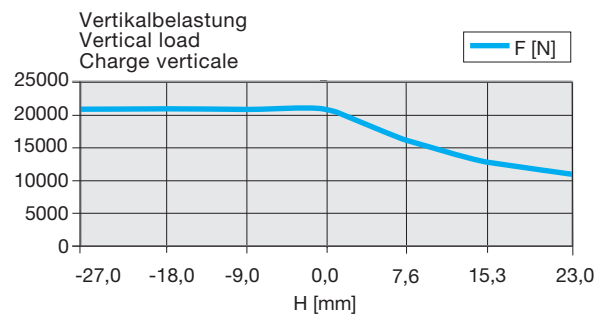
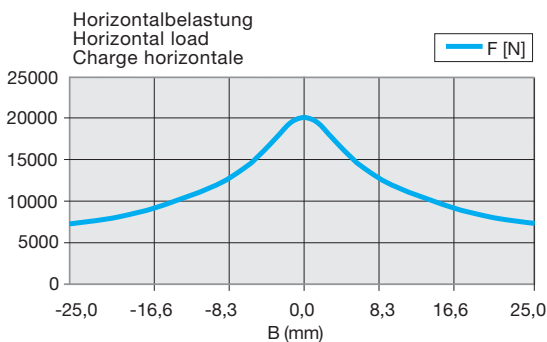

B	-25,0	-16,6	-8,3	0,0	8,3	16,6	25,0	H	-27,0	-18,0	-9,0	0,0	7,6	15,3	23,0
F (N)	7130	9000	12415	20000	12415	9000	7130	F (N)	20610	20405	20200	20000	15650	12855	11075
%	35	45	62	100	62	45	35	%	103	102	101	100	78	64	55

D 3002A 07.2018

SN5620-3000

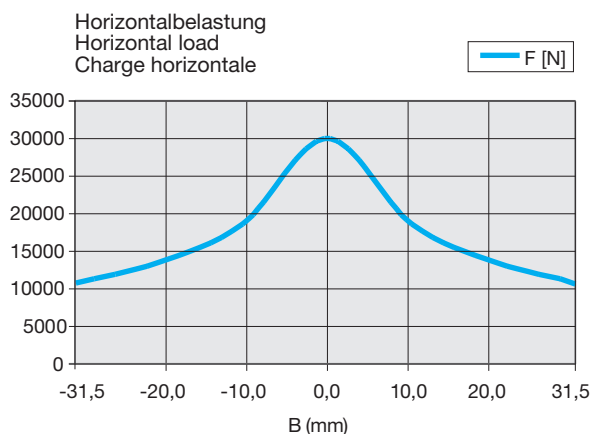

B	-31,5	-21,0	-10,5	0,0	10,5	21,0	31,5
F (N)	10693	13500	18620	30000	18620	13500	10693
%	36	45	62	100	62	45	36

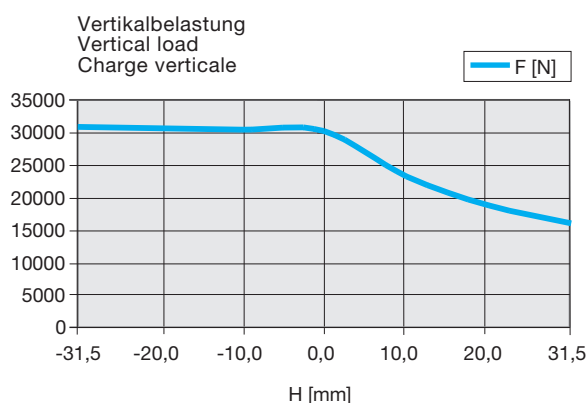

H	-31,5	-21,0	-10,5	0,0	10,5	21,0	31,5
F (N)	30900	30600	30300	30000	23478	19285	16615
%	103	102	101	100	78	64	55

SN5620-5000

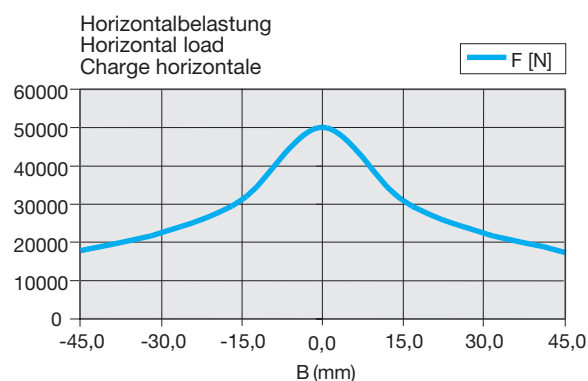

B	-45,0	-30,0	-15,0	0,0	15,0	30,0	45,0
F (N)	17800	22500	31050	50000	31000	22500	17800
%	36	45	62	100	62	45	35,5

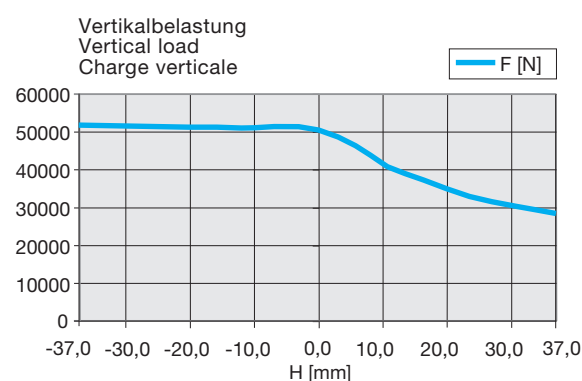

H	-37,0	-24,6	-12,3	0,0	12,3	24,6	37,0
F (N)	51500	51000	50500	50000	39130	32142	27692
%	103	102	101	100	78	64	55

SN5620-15000

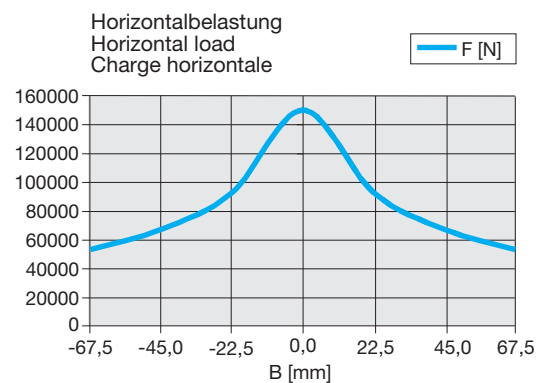

B	-67,5	-45,0	-22,5	0,0	22,5	45,0	67,5
F (N)	53400	67500	93000	150000	93000	67500	53400
%	36	45	62	100	62	45	36

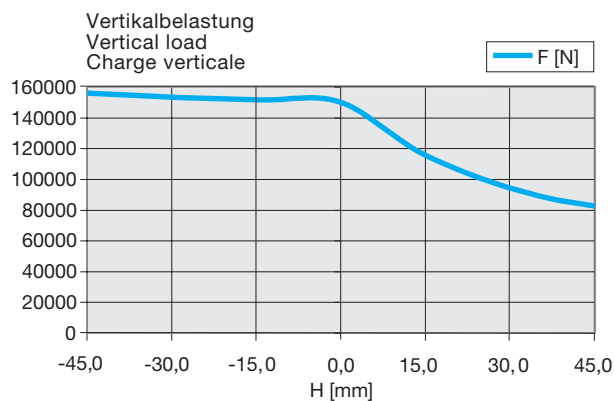

H	-45,0	-30,0	-15,0	0,0	15,0	30,0	45,0
F (N)	154500	153000	151500	150000	117390	96425	83075
%	103	102	101	100	78	64	55