

### Großschieber in Sonderausführung

Schieber nach Kundenwunsch / Konstruktionsvorgabe.  
Ausführungsvarianten und Materialien 1.2343, 1.2767,  
1.2311 frei konfigurierbar.  
Härten / Nitrieren auf Anfrage.

V = Verschraubung für Schieberaufsatz  
K = Kühlbohrungen mit Kühlschluss Z7713  
D = Druckplatte 1.2842  
S = Schieberaufsatz 1.2343, 1.2767, 1.2311

### Large slides in special design

Slider according to customer requirements / design  
specifications. Variants and materials 1.2343, 1.2767,  
1.2311 freely configurable.  
Hardening / nitriding on request.

V = Screwing for slide attachment  
K = Cooling holes with cooling connection Z7713  
D = Pressure plate 1.2842  
S = Slider attachment 1.2343, 1.2767, 1.2311

### Coulisseaux de grande dimension au design spécial

Tiroir selon les exigences du client / spécifications de  
conception. Variantes et matériaux 1.2343, 1.2767,  
1.2311 librement configurable.  
Durcissement / nituration sur demande.

V = Raccord à vis pour fixation de tiroir  
K = Trous de refroidissement avec raccord de  
refroidissement Z7713  
D = Plaque de pression 1.2842  
S = Fixation de tiroir 1.2343, 1.2767, 1.2311

5

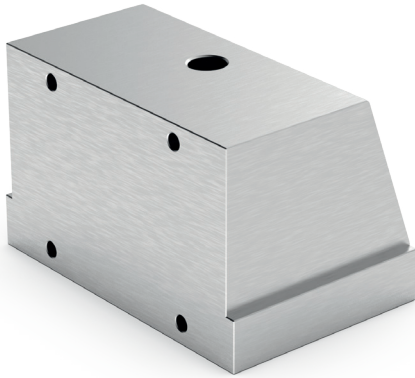

V	<input checked="" type="checkbox"/>	Type 15
K	<input type="checkbox"/>	
D	<input type="checkbox"/>	
S	<input type="checkbox"/>	

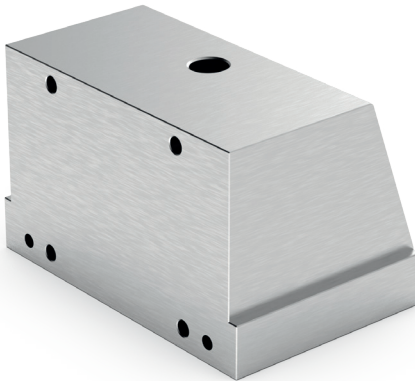

V	<input checked="" type="checkbox"/>	Type 20
K	<input checked="" type="checkbox"/>	
D	<input type="checkbox"/>	
S	<input type="checkbox"/>	

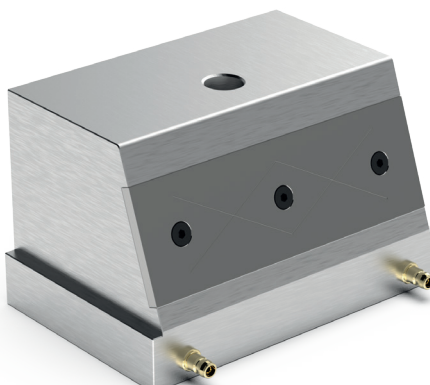
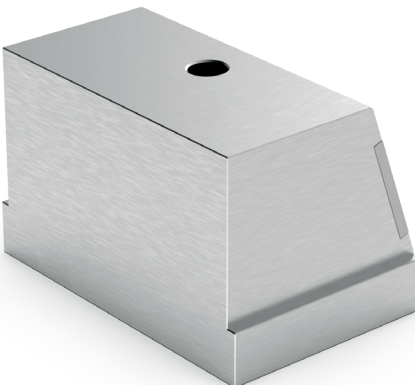

V	<input type="checkbox"/>	Type 25
K	<input checked="" type="checkbox"/>	
D	<input checked="" type="checkbox"/>	
S	<input type="checkbox"/>	

D 3002A 05.2022

## Großschieber in Sonderausführung

## Large slides in special design

## Coulisseaux de grande dimension au design spécial

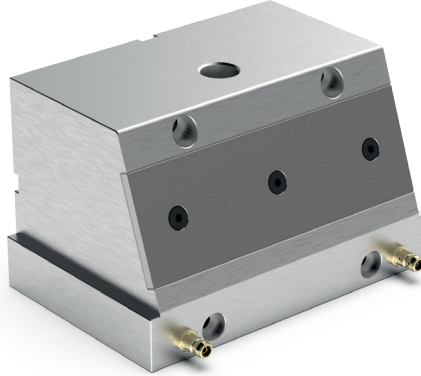

V	<input checked="" type="checkbox"/>	Type 30
K	<input checked="" type="checkbox"/>	
D	<input checked="" type="checkbox"/>	
S	<input type="checkbox"/>	



V	<input checked="" type="checkbox"/>	Type 35
K	<input checked="" type="checkbox"/>	
D	<input checked="" type="checkbox"/>	
S	<input checked="" type="checkbox"/>	

5

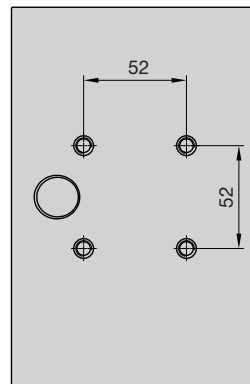
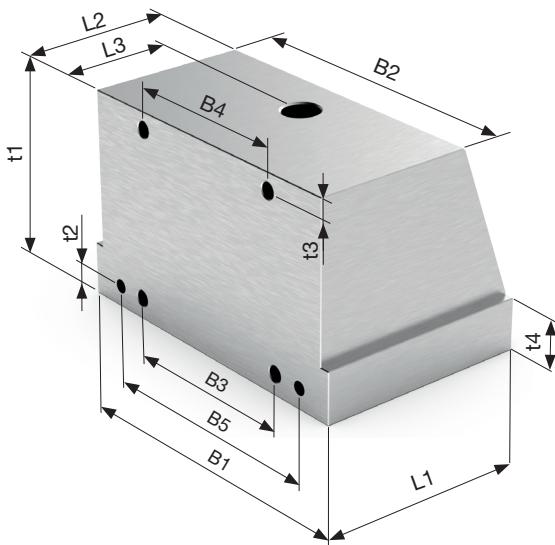

Alle Schieber haben auf der Unterseite Stich-Maß Bohrungen für Null-Punkt Spannsysteme.

All sliders have stitch gauges for boreholes on the underside for zero-point clamping systems.

Tous les tiroirs ont sur leur face inférieure perçages d'entraxe pour les systèmes de serrage à zero point.

Bestellschlüssel / Order code / Code de commande: Z421XX-B2-t1-L1-B1-t4-L2-L3-t2-t3-B3-B4-B5-Material  
XX = Type

D 3002A 05.2022