

Mini compact ejector

SCPMc 10 S04 NC M8-6 NPN AA8

Part no.:10.02.02.05751

<https://www.schmalz.com/10.02.02.05751>

Homepage > Vacuum Technology for Automation > Vacuum Components > Vacuum Generators > Compact ejectors > Compact Ejectors SCPM
/ SCPMc / SCPMi > SCPMc 10 S04 NC M8-6 NPN AA8

Mini Compact Ejector with air-saving function and display with



Nozzle size: 1,0 mm
 Connection: Hose D6(1)-D6(2)
 Suction rate (max): 28 l/min
 Air consumption (during evac.):
 45 l/min
 Noise level (free): 71 dB
 Pressure range (operating pressure):
 3.0 ... 6.0 bar
 Vacuum (max): 870 mbar
 Control: Normally closed
 Electrical connection:
 Male connect M8, 6 pole
 Type: Switches to minus
 Protection: IP 40

Design Data

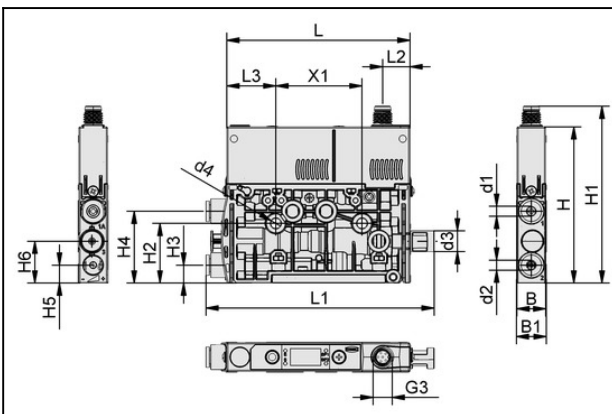

Attribute	Value
B	12 mm
B1	12.5 mm
d1	6.2 mm
d2	6.2 mm
d3	9 mm
d4	4.3 mm
G3	M8x1-M
H	65.3 mm
H1	73.9 mm

Mini compact ejector

SCPMc 10 S04 NC M8-6 NPN AA8

Part no.:10.02.02.05751

<https://www.schmalz.com/10.02.02.05751>



Attribute	Value
H2	24.95 mm
H3	7.5 mm
H4	30 mm
H5	7.5 mm
H6	17.5 mm
L	76.5 mm
L1	98.3 mm
L2	11.4 mm
L3	20.5 mm
X1	36 mm

Technical Data

Attribute	Value
Nozzle size	10
Degree of evacuation	87 %
Suction rate (max.)	28 l/min
Air consumption suction	45 l/min
Max. air consumption blow off	10 l/min
Max. vacuum	870 mbar
Control valve	NC
Electrical connection	M8-6
Pressure range (operating pressure)	3.0 ... 6.0 bar
Recomm. internal hose diameter compressed air	4 mm
Recomm. internal hose diameter vacuum	4 mm
Weight	70 g

Contact to Schmalz

J. Schmalz GmbH | Johannes-Schmalz-Straße, 72293 Glatten, Deutschland | +49 7443 2403-102 | customercenter@schmalz.de

Mini compact ejector

SCPMc 10 S04 NC M8-6 NPN AA8

Part no.:10.02.02.05751

<https://www.schmalz.com/10.02.02.05751>

Attribute	Value
Operating temperature	0 ... 50 °C
Air consumption suction	1.589 cfm
Suction rate (max.)	0.988 cfm
Max. vacuum	25.691 inHg

Spare Parts



SD-EINS 6.4x21.8 SCPM

Part no.10.02.02.05806

Silencer insert

External diameter D: 6.4 mm

Length L: 21.8 mm

for: Compact ejectors SCP

Accessories



ASK WB-M8-6 2000 K-6P

Part no.21.04.05.00488

Connection cable

Cable length: 2000 mm

Mini compact ejector

SCPMc 10 S04 NC M8-6 NPN AA8

Part no.:10.02.02.05751

<https://www.schmalz.com/10.02.02.05751>



ASK WB-M8-6 2000 S-M12-5

Part no.21.04.05.00489

Connection cable

Cable length: 2000 mm



ASK B-M8-6 5000 K-6P

Part no.21.04.05.00255

Connection cable

Interface Connection 1:

Fem connect M8, 6 pol

Cable length: 5000 mm

Interface Connection 2: Cable 6

Material: PUR-Cable



ASV SCPMi B-M8-6 2xS-M12-4

Part no.10.02.02.05602

Connection distributor

for: SCPMi

Interface Connection 2:

2xConnect M12, 4 pol

Length L: 1000 mm

Mini compact ejector

SCPMc 10 S04 NC M8-6 NPN AA8

Part no.:10.02.02.05751

<https://www.schmalz.com/10.02.02.05751>



HUT-SN-KL 50x14x7 SCPMi/c/b

Part no.10.02.02.05805

Top-hat rail clamp comp.

Length L: 50 mm

Width B: 14 mm

Height H: 7 mm

for: Comp. ejectors SCPMi/c/b



BEF-WIN 15x50x36.1 1.5 SCPM

Part no.10.02.02.05824

Mounting bracket

Width B: 15 mm

Height H: 50 mm

Length L: 36.1 mm

Wall thickness s: 1.5 mm

for: Compact ejectors SCP



STV-GE M5-AG 4

Part no.10.08.02.00468

Push-in Fitting, straight

Thread G1: M5-M

External hose diameter: 4 mm

Material: Brass

Surface: nickel plated

Mini compact ejector

SCPMc 10 S04 NC M8-6 NPN AA8

Part no.:10.02.02.05751

<https://www.schmalz.com/10.02.02.05751>



STV-GE M7-AG 6

Part no.10.08.02.00469

Push-in Fitting, straight

Thread G1: M7-M

External hose diameter: 6 mm

Material: Brass

Surface: nickel plated