

# TESTINA PRENSILE

PICK-UP HEAD

TETE DE PREHENSION

GREIFERKOPF

TULIPA

cod. 001.0081 ø 70

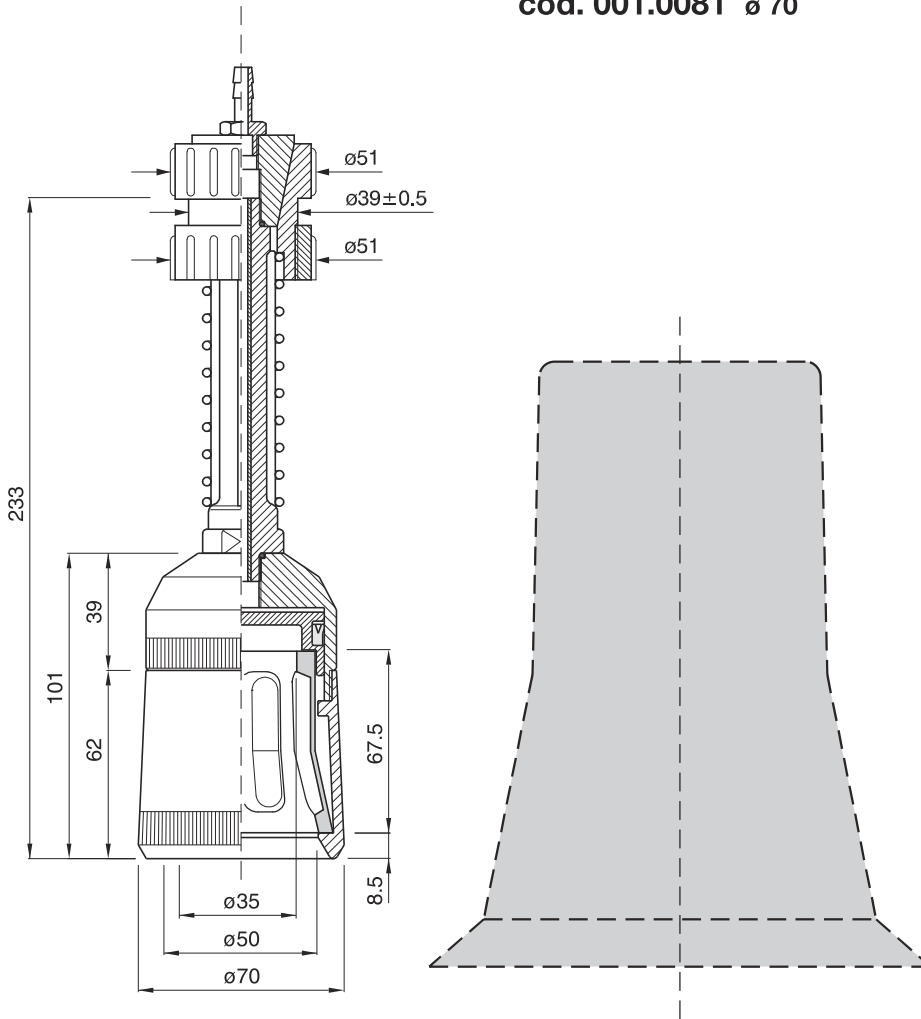

PROFILO INTERNO SCALA 1:1  
 INTERNAL SECTION SCALE 1:1  
 PROFIL INTERNE ECHELLE 1:1  
 INNENPROFIL MASSTAB 1:1  
 PERFIL INTERIOR ESCALA 1:1

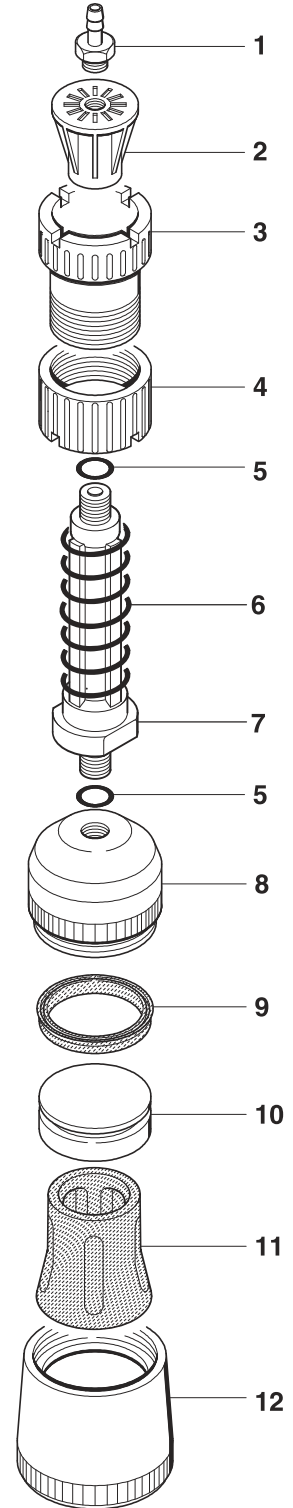

	COD.	MATERIALE	MATERIAL	MATERIEL	WERKSTOFF	MATERIAL
1	024.0001	OTTONE	BRASS	LAITON	MESSING	LATÓN
2	025.0001	PA	PA	PA	PA	PA
3	026.0001	PA	PA	PA	PA	PA
4	026.0011	PA	PA	PA	PA	PA
5	057.0033	GOMMA	RUBBER	CAOUTCHOUC	GUMMI	GOMA
6	029.0001	AISI	STAINLESS STEEL	ACIER INOXYDABLE	ROSTFREIER STAHL	ACERO INOXIDABLE
7	028.0001	AL	AL	AL	AL	AL
8	027.0064	PA	PA	PA	PA	PA
9	041.0050	TPU	TPU	TPU	TPU	TPU
10	031.0014	PA	PA	PA	PA	PA
11	040.0134	PUR	PUR	PUR	PUR	PUR
12	026.0114	PA	PA	PA	PA	PA