

TESTINA PRENSILE

PICK-UP HEAD

TETE DE PREHENSION

GREIFERKOPF

TULIPA

cod. 001.00422 ø 58

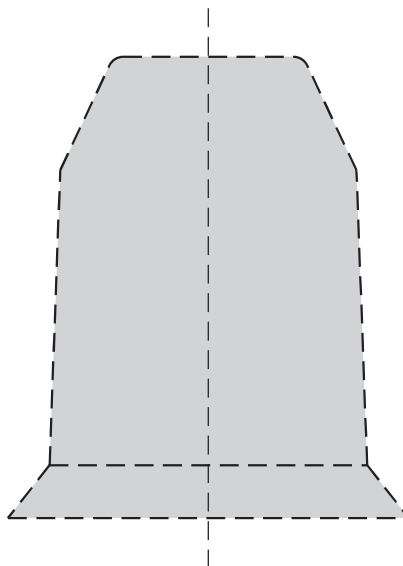
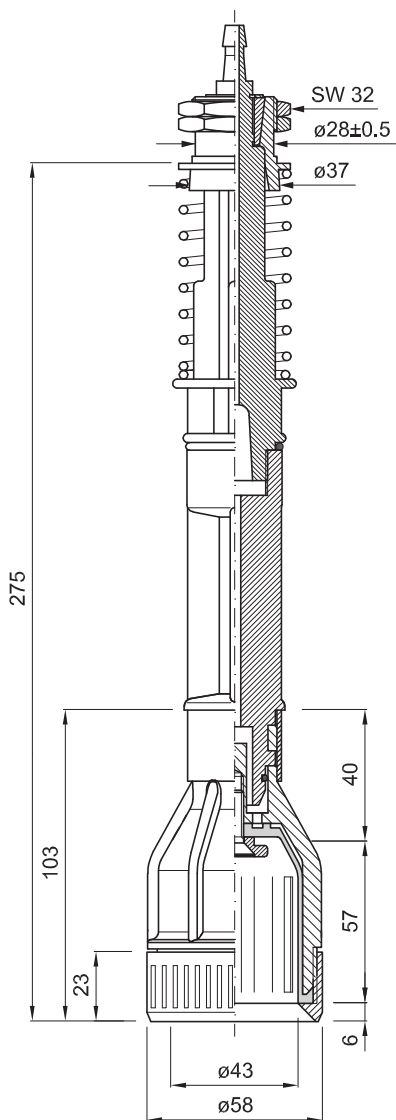

PROFILO INTERNO SCALA 1:1
INTERNAL SECTION SCALE 1:1
PROFIL INTERNE ECHELLE 1:1
INNENPROFIL MASSTAB 1:1
PERFIL INTERIOR ESCALA 1:1

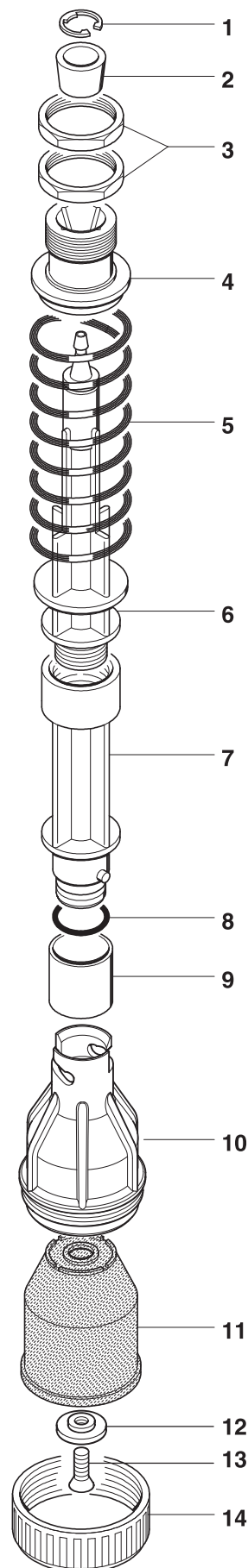

	COD.	MATERIALE	MATERIAL	MATERIEL	WERKSTOFF	MATERIAL
1	032.0014	AISI	STAINLESS STEEL	ACIER INOXYDABLE	ROSTFREIER STAHL	ACERO INOXIDABLE
2	025.0002	PA	PA	PA	PA	PA
3	032.0015	AISI	STAINLESS STEEL	ACIER INOXYDABLE	ROSTFREIER STAHL	ACERO INOXIDABLE
4	026.0002	PA	PA	PA	PA	PA
5	029.0008	AISI	STAINLESS STEEL	ACIER INOXYDABLE	ROSTFREIER STAHL	ACERO INOXIDABLE
6	028.0037	PA	PA	PA	PA	PA
7	028.0036	PA	PA	PA	PA	PA
8	057.0017	GOMMA	RUBBER	CAOUTCHOUC	GUMMI	GOMA
9	026.00631	PP	PP	PP	PP	PP
10	027.0035	PA	PA	PA	PA	PA
11	040.0053	GOMMA / TPU	RUBBER / TPU	CAOUTCHOUC TPU	GUMMI / TPU	GOMA / TPU
12	030.0043	PA	PA	PA	PA	PA
13	032.0012	AISI	STAINLESS STEEL	ACIER INOXYDABLE	ROSTFREIER STAHL	ACERO INOXIDABLE
14	026.0064	PA	PA	PA	PA	PA