

Standard separator, wide foot
unassembled **56.1**
assembled **56.1.1**

Standard - for all applications

Separator with wide foot for maximum locking strength and safe standing in E-Chains® and E-Tubes.

Separator, narrow foot
unassembled **56.3**
assembled **56.3.1**

For many thin cables

Separator with narrow foot for a large number of thin cables side by side. Saves space in E-Chains® and E-Tubes. Also available for QuickLock crossbars.

Asymmetrical separator
unassembled **56.4**
assembled **56.4.1**

For side-mounted applications

Asymmetrical separator, for defined distance. No additional spacers necessary for E-Chains® and E-Tubes.

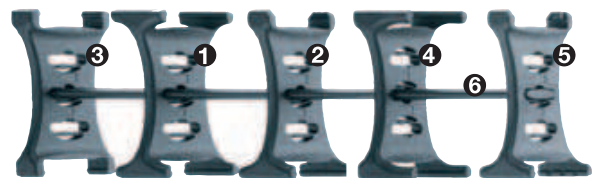
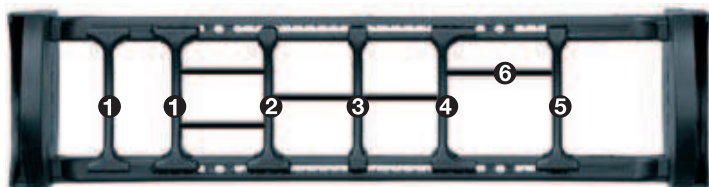

- ① Standard separator, wide foot - Part No. 56.1
- ② Separator for QuickLock crossbar - Part No. 56.2
- ③ Separator, narrow foot - Part No. 56.3
- ④ Separator, asymmetrical - Part No. 56.4
- ⑤ Notch separator - Part No. 56.5
- ⑥ Full-width shelf, lockable - Part No. 520.XX



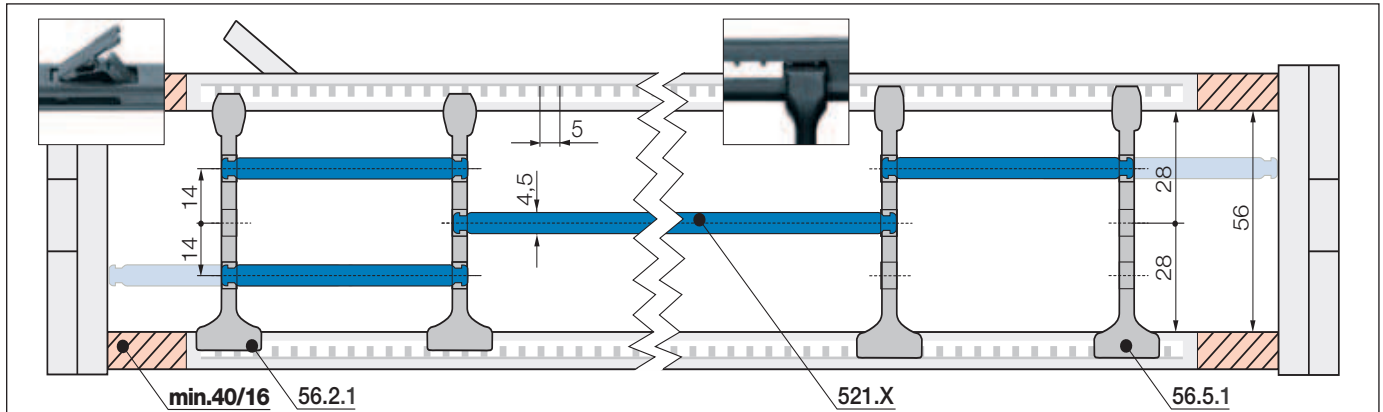

Note: Please observe a lateral spacing to the sidelinks! **E-Tube: 40 mm | E-Chain®: 16 mm**
In the standard configuration separators are assembled every 2nd E-Chain® link !



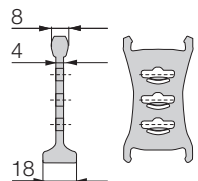

Separator for QuickLock crossbar		
unassembled	56.2	
assembled	56.2.1	

For even faster installation

Separator for igus® QuickLock crossbar 450.X.Q. Firm hold to one side with a wide foot, narrow on opposed side for easy cable assembly (slight grip). For E-Tubes also.



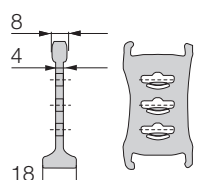

Notch separator for notch crossbar		
unassembled	56.5	
assembled	56.5.1	

Locks safely onto in 5 mm increments

Notch separator for the new notch crossbar, with scaling on the notch crossbars. For exact positioning in E-Chains® and E-Tubes. Recommended for side-mounted applications.



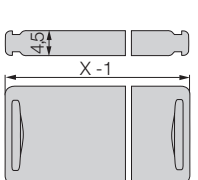

Full-width shelf, lockable		
unassembled	520.X	
assembled	521.X	

Horizontal separation

Shelf locks safely into separators on both ends, fixed width possible. Separators can be moved freely over the shelf in horizontal direction. Usable in 3 levels.

Lockable full-width shelves - for the standard interior separation

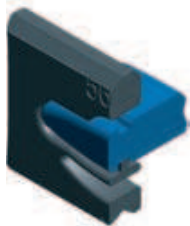

Width X [mm]	unassembled	assembled	Width X [mm]	unassembled	assembled	Width X [mm]	unassembled	assembled
050	520.050	521.050	125	520.125	521.125	225	520.225	521.225
062	520.062	521.062	150	520.150	521.150	250	520.250	521.250
075	520.075	521.075	175	520.175	521.175	300	520.300	521.300
100	520.100	521.100	200	520.200	521.200	450	520.450	521.450



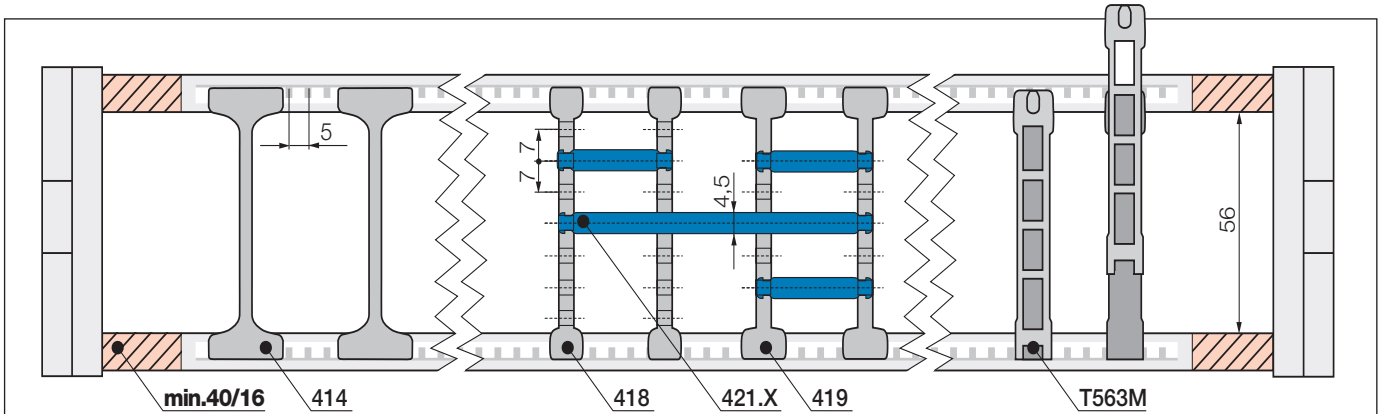

Note: Please observe a lateral spacing to the sidelinks! **E-Tube: 40 mm | E-Chain®: 16 mm**
In the standard configuration separators are assembled every 2nd E-Chain® link !

			Open slotted separator for E-Chains®/E-Tubes unassembled 409 assembled 419
			Slotted separator for E-Chains®/E-Tubes unassembled 408 assembled 418
			Split separator for E-Chains® unassembled T563 assembled T563M
			Locking separator for E-Chains® unassembled 404 assembled 414
			Shelf unassembled 420.X assembled 421.X

Open, slotted separator 409 (unilateral open)

Fast assembly - can be retrofitted into an existing interior separation system without a need for dismantling the interior separators. During an installation of open slotted separators, the top and bottom notches cannot be occupied by shelves.

Slotted separator 408

For very fine subdivisions. However, they cannot be retrofitted into an existing separation system without dismantling the interior separators first.

Split separator T563 (E-Chains® only)

Ideal for subsequent shelving or for the initial assembly of the E-Chain® without a need for dismantling the interior separators.

Locking separator 404 (E-Chains® only)

For applications exposed to very high humidity (> 85%). Locks with extra retention force. Tip: one locking separator per E-Chain® link for better mounting.

Shelf 420.X

For horizontal separation. Shelves of various widths can be arranged at 7 different heights (in 7 mm increments). (not in combination with 404).

Shelves - interior separation options

Width X [mm]	unassembled	assembled	Width X [mm]	unassembled	assembled	Width X [mm]	unassembled	assembled
018	420.18	421.18	050	420.50	421.50	150	420.150	421.150
023	420.23	421.23	062	420.62	421.62	175	420.175	421.175
025	420.25	421.25	075	420.75	421.75	187	420.187	421.187
028	420.28	421.28	088	420.88	421.88	200	420.200	421.200
033	420.33	421.33	100	420.100	421.100			
043	420.43	421.43	125	420.125	421.125			

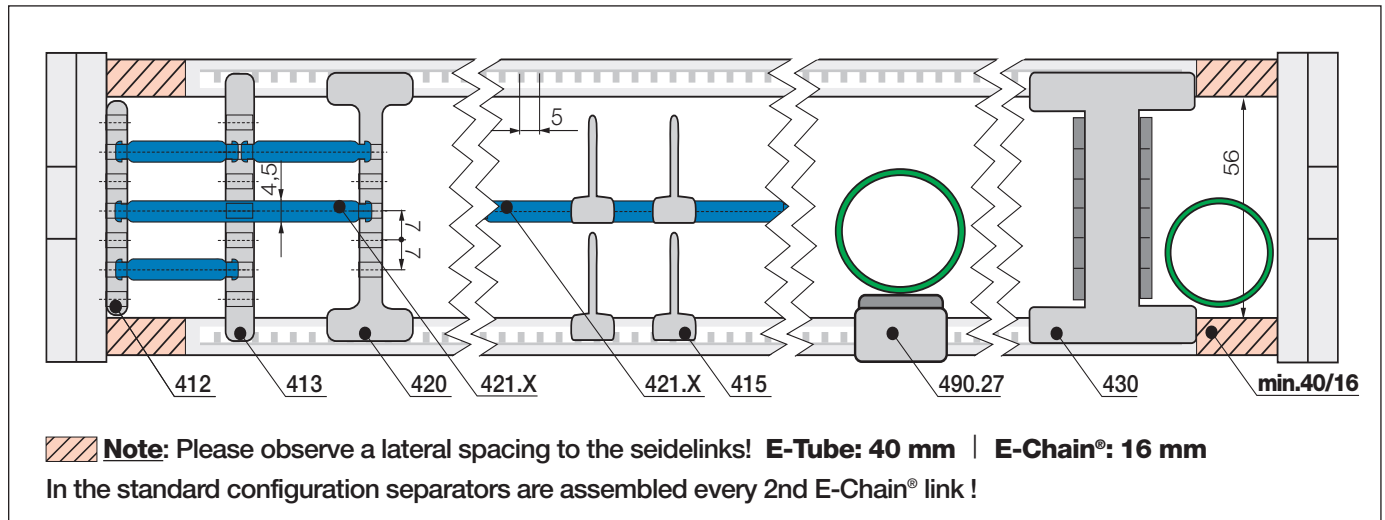

		Middle plate for E-Chains® / E-Tubes unassembled 403 assembled 413
		Locking vertical separator for E-Chains® unassembled 410 assembled 420
		Side plate for E-Chains® / E-Tubes unassembled 402 assembled 412

Middle plate 403

Middle plates form the basic pattern of a shelf system. Shelves 420.X (table left page) can be arranged at 7 different heights (in 7 mm increments).

Locking vertical separator 410 (E-Chains® only)

Works like middle plate, for applications exposed to very high humidity (> 85%).

Side plate 402

Works like middle plate. Allows modular shelving close to the side links.

Additional elements for interior separation

		Center crossbar for E-Chains® unassembled 405 assembled 415
		Rollclip for E-Chains® unassembled 489.27 assembled 490.27
		Roller separator for E-Chains® unassembled 429 assembled 430

Center crossbar

For applications with a large number of thin cables. The center crossbar offers the option of subdividing the E-Chain® independently into upper and lower halves.

Rollclip

Minimizes abrasion of particularly sensitive hoses - simply clamped onto the opening crossbar. The movable rollers compensate for relative movement between the E-Chain® and hose.

Roller separator

Performs a similar function to the Rollclip, but doubles as a separator. For rigid cables and hoses.

