

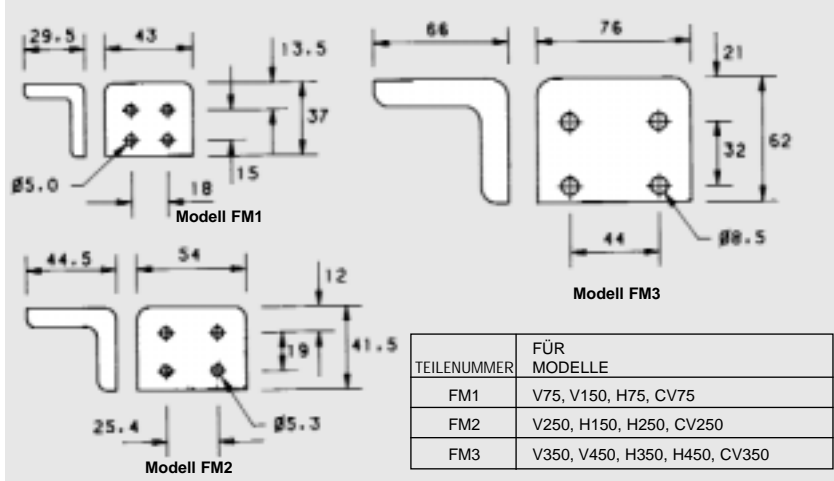

ZUBEHÖR FÜR  
SPANNELEMENTE,  
MANUELL UND PNEUMATISCH

# ZUBEHÖR FÜR SPANNELEMENTE

## BEFESTIGUNGSWINKEL FÜR VERTIKAL- UND HORIZONTALSPANNER FÜR STIRNSEITIGE MONTAGE



## BEFESTIGUNGEN FÜR SCHUBSTANGENSPELLER

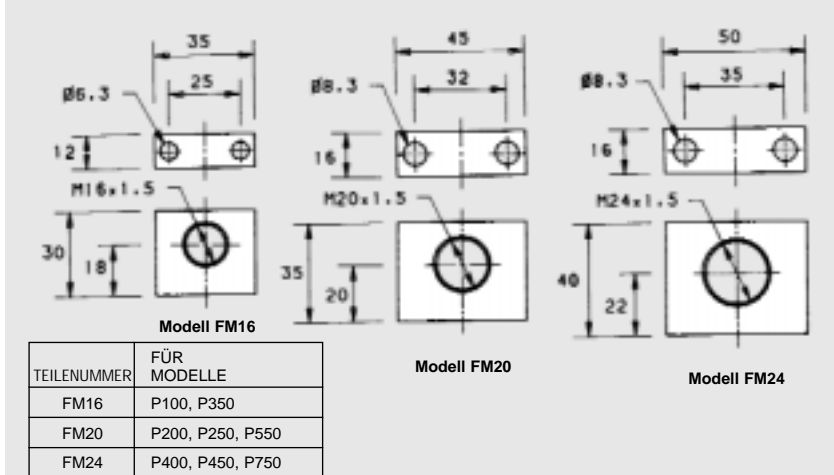

## ANDRUCKSCHRAUBEN



## ANDRUCKSPINDELN

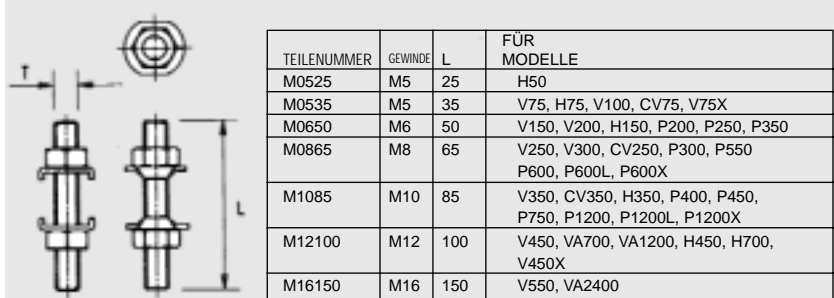

## ANDRUCKSPINDELN MIT GELENKFÜß

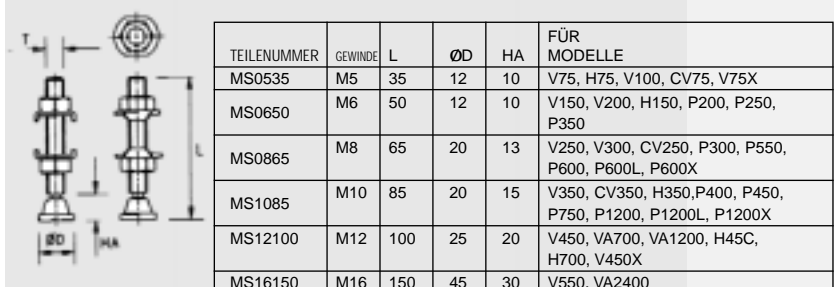

## ANDRUCKSPINDEL MIT NEOPREN DRUCKSTÜCK

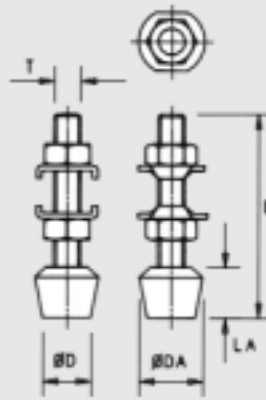

TEILENUMMER	GEWINDE	L	LA	ØD	ØDA	FÜR MODELLE
NTS0432	M4	32				P50
NTS0538	M5	38	11	10	13	H50, V75, H75, V100, CV75, V75X
NTS0645	M6	45	13	12	16	V150, V200, H150, P200, P250, P350
NTS0865	M8	65	16	16	21	V250, V300, CV250, P300, P550, P600, P600L, P600X
NTS1085	M10	85	20	22	27	V350, CV350, H350, P400, P450, P750, P1200, P1200L, P1200X
NTS12100	M12	100	24	24	30	V450, VA700, VA1200, H450, H700, V450X

## NEOPREN ANDRUCKSCHRAUBEN SCHUTZKAPPEN

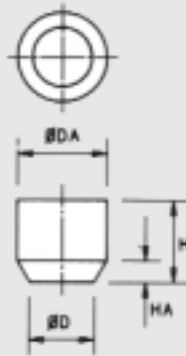

TEILENUMMER	H	HA	ØD	ØDA	FÜR ANDRUCKSCHRAUBEN
NC/04	8	4	7	11	MB0420
NC/05	10	4	11	13	MB0525, MB0535
NC/06	12	4	12	15	MB0650
NC/08	15	6	13	19	MB0860
NC/10	18	7	16	23	MB1080
NC/12	20	7	19	26	MB1260, MB12100

## NEOPREN DRUCKSTÜCKE

FÜR ANDRUCKSPINDELN

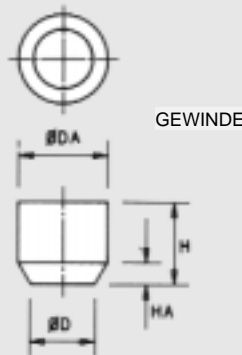

TEILENUMMER	GEWINDE	H	HA	ØD	ØDA	FÜR ANDRUCKSPINDELN
NP/05	-	10	2	-	12	M0525, M0535
NP/06	M6	12	4	12	15	M0650
NP/08	M8	15	6	13	19	M0865
NP/10	M10	18	7	16	23	M1085
NP/12	M12	20	7	19	26	M12100

## PLASTIK SCHUTZKAPPEN

FÜR ANDRUCKSPINDELN MIT GELENKFUß

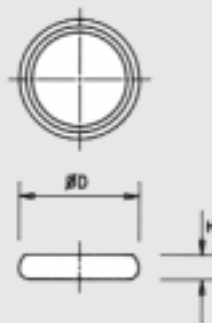

TEILENUMMER	ØD	H	FÜR ANDRUCKSPINDELN
NPS/05/06	16	6	MS0535, MS0650
NPS/08/10	24	10	MS0865, MS1085
NPS/12	30	10	MS12100

## KLEMMSCHEIBEN

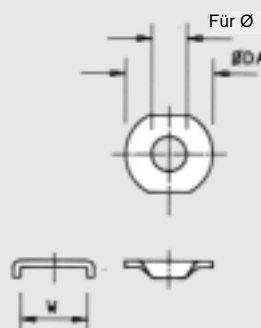

TEILENUMMER	GEWINDE	W	ØDA	PASSEND FÜR MODELL
FW05/09	M5	9	13	H50
FW05/10	M5	10	15	H75, V75, V75X, V100
FW06/12	M6	12	18	H150, V150, V150X, V200
FW08/15	M8	15	22	H250, V250, V250X, V300
FW10/20	M10	20	26	H350, V350
FW12/23	M12	23	32	H450, V450, V450X, H700
FW16/27	M16	27	35	V550

## ANDRUCKSPINDEL- BEFESTIGUNGEN

FÜR ANDRUCKSPINDELN UND ANDRUCKSCHRAUBEN

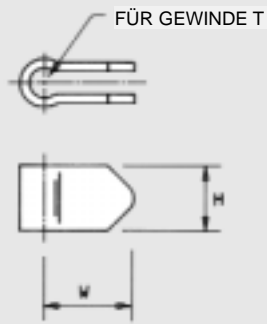

TEILENUMMER	T GEWINDE	H	W	PASSEND FÜR MODELL
R/08	M8	17.5	24	V250, H250, V300
R/10	M10	22	30	V350, H350
R/12	M12	26	32	V450, H450
R/16	M16	32	35	V550

## PVC GRIFF UMMANTELUNGEN

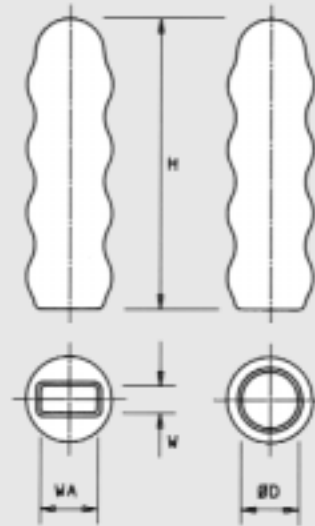

TEILNUMMER	H	INNENMAßE			PASSEND FÜR MODELL
		W	WA	ØD	
GR/01	45	4	8		H75, V75, CV75, V100, H100
GR/02	60	5	10		H150
GR/03	53	6	10		V150, LH200
GR/04	55	5	13		H200
GR/05	58	4	13		V200, P100
GR/06	85	6	15		V250, H250, CV250, V300, LH400, P200, P350
GR/07	65	6	16		H300
GR/08	60	5	13		P250
GR/09	105	8	17		V350, CV350, H350, P400, P450, P550, TC79
GR/10	95	10	22		V450, H450, LH700
GR/11	120	10	25		V550
GR/12	105	8	19		H700
GR/13	115	8	22		P750
BR/1	70			9.5	P600L
BR/2	75			12.7	P1200L
BR/3	100			16	P2500L
B7	90			19	VA700, P5000L
B12	100			22	VA1200
B24	100			25	VA2400