



5346-5349

**BAGUE BRIDEE
EXTRA LONGUE SINT-GR**
SINT-GR DEMOUNTABLE BUSH
EXTRA LONG

- REF. 5346 D1=25 H=23 → 5346-25-23
- REF. 5349 D1=40 H=30 → 5349-40-30

FABRICATIONS SPÉCIALES SUR DEMANDE
SPECIAL MANUFACTURE ON REQUEST



NF E 63-123

Ensemble / Set REF. 5346

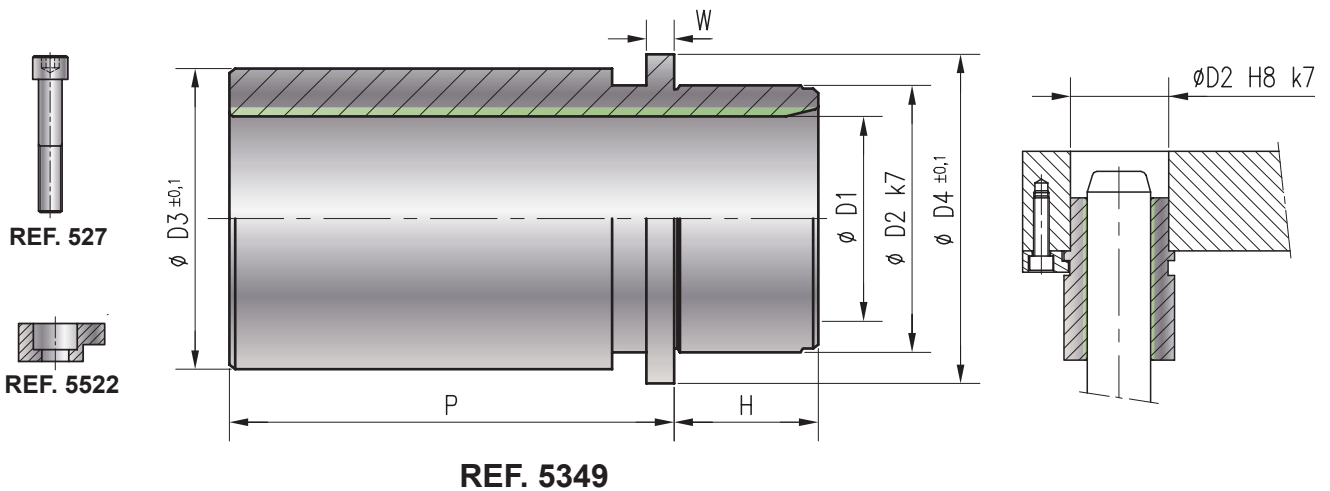

REF. 527	M5 x 12	M6 x 16	M6 x 16	M8 x 20	M10 x 20	
D2	40	50	63	80	90	
D3	41	51	65	84	100	
D4	45	56	70	90	110	
W	4	5	5	6	10	
P	71	71	80	100	100	
Type 5522	2	3	3	4	5	
Nb 5522	2	3	3	3	4	
<div style="display: flex; align-items: center;"> <div style="writing-mode: vertical-rl; transform: rotate(180deg);">H</div> <div style="margin-left: 10px;"> $\frac{D1}{H}$ </div> </div>	25	32	40	50	63	
	23					
	28					
	30					
	38					
	48					



la solution autolubrifiante par REVETEMENT SINTER

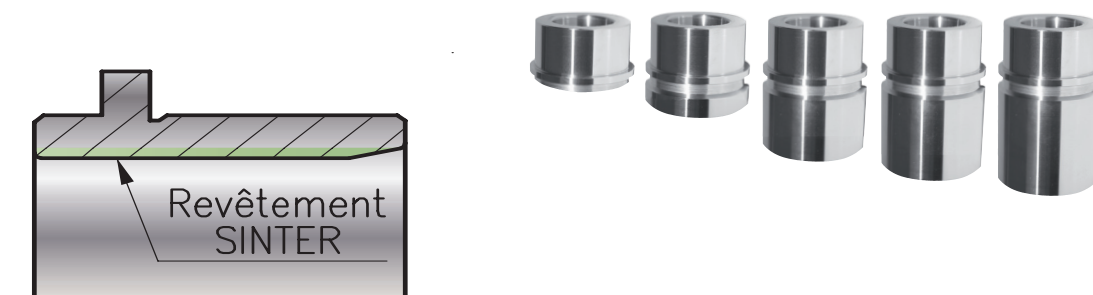

BAGUE SINT-ER AVEC REVETEMENT SINTER SINT-ER BUSH

REF. : 5385 - 5386 - 5387 - 5388 - 5389
ensembles / set : 5380 - 5381 - 5382 - 5383 - 5384

- Interchangeabilité avec standard du marché
- Détrompage avec une gamme de diamètres intermédiaires
- Un encombrement plus Réduit (ER)

BAGUE SINT-GR AVEC REVETEMENT SINTER SINT-GR BUSH

REF. : 5347 - 5348 - 5349
ensembles / set : 5343 - 5344 - 5346 - 5345

- Interchangeabilité avec les bagues «lubracier et bronzacier»

BENEFICES

- Utilisation avec ou sans lubrification
- Utilisation optimum de 6 à 10 m/mn
- Durée de vie prolongée de 50% par rapport aux bagues de guidages lisses classiques
- Pas de détérioration du matériau, idéal dans un environnement propre

INTERCHANGEABILITÉ DES BAGUES SINT-GR AVEC LES BAGUES «BRONZACIER» ET «LUBRACIER»



Les bagues SINT-GR remplacent en lieu et place les bagues «Bronzacier» et «Lubracier» :
 Gamme des «bronzacier» + gamme des «lubracier» = gamme des bagues SINT-GR

“BRONZACIER”

“LUBRACIER”

SINT-GR AVEC REVÊTEMENT SINTER

CORRESPONDANCE ENTRE LES BAGUES COURTES

Ensemble / Assembly REF. 5353

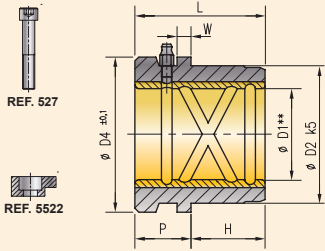

** G6 D1 \leq 25
 G5 D1 $>$ 25 REF. 5357

Ensemble / Assembly REF. 5363

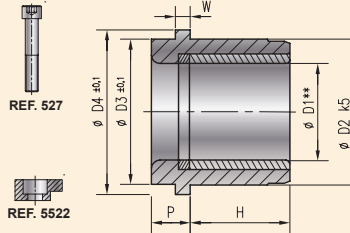

** G6 D1 \leq 25
 G5 D1 $>$ 25 REF. 5367

Ensemble / Set REF. 5343

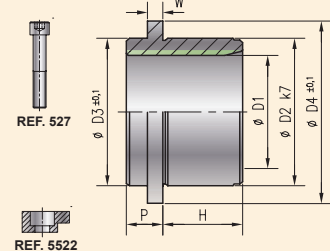

REF. 5347

CORRESPONDANCE ENTRE LES BAGUES LONGUES

Ensemble / Assembly REF. 5354

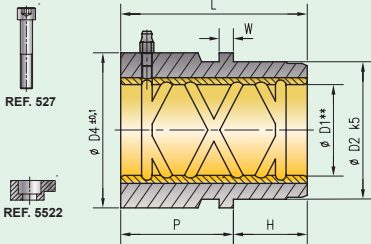

** G6 D1 \leq 25
 G5 D1 $>$ 25 REF. 5358

Ensemble / Assembly REF. 5364

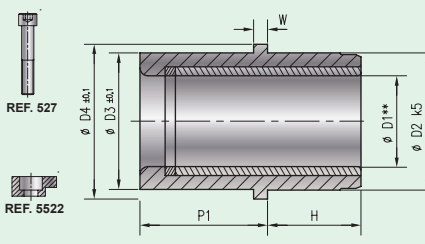

** G6 D1 \leq 25
 G5 D1 $>$ 25 REF. 5368

Ensemble / Set REF. 5344

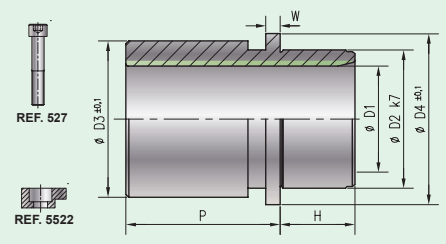

CORRESPONDANCE ENTRE LES BAGUES EXTRA LONGUES

Ensemble / Assembly REF. 5356

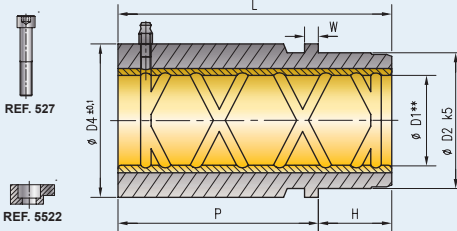

** G6 D1 \leq 25
 G5 D1 $>$ 25 REF. 5359

Ensemble / Set REF. 5346

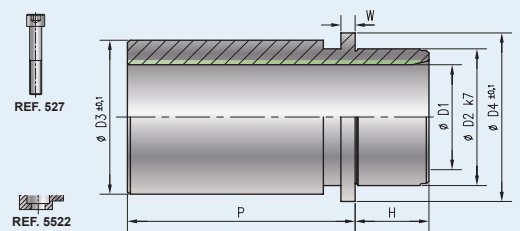

REF. 5349

CORRESPONDANCE ENTRE LES BAGUES FILETÉES

Ensemble / Assembly REF. 5355

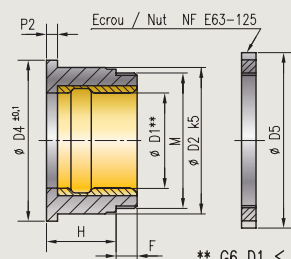

** G6 D1 \leq 25
 G5 D1 $>$ 25

Ensemble / Assembly REF. 5365

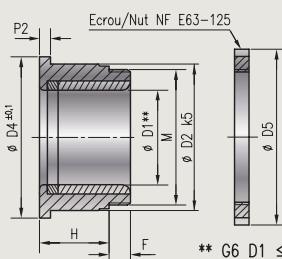

** G6 D1 \leq 25
 G5 D1 $>$ 25

Ensemble / Set REF. 5345

